

## INFLUENCE OF ELECTRIC FIELD ON WHEAT GRAIN DRYING\*

*W. Pietrzyk, A. Sumorek*

Department of General Electrical Engineering, Lublin Technical University, Nadbystrzycka 38a  
20-618 Lublin, Poland, E-mail: jwipi@elektron.pol.lublin.pl

*Accepted February 9, 1998*

**A b s t r a c t.** Because of the numerous common applications of drying processes their energy consumption reduction is an important task. This reduction can be achieved by using appropriate drying methods and/or introducing factors to intensify the process. The electrostatic field seems to be one of the factors that force convective drying. The paper presents the results of convective drying of wheat grain in an electrostatic field.

**K e y w o r d s:** electrostatic field, convective drying, wheat grain

### INTRODUCTION

A single wheat grain can be treated as a laminar spheroid. After exposing this grain in an electric field some forces can appear. These are caused by:

- free charges which the grain can gain in the ionised environment. The force is big enough to be used in ionic cleaning plants;
- the unbalance of electric charge inside the grain. This force is used in electrostatic separators with bifilar winding;
- charges induced on the border of grain layers (electrostrictive forces);
- free charges which can appear in the environment. In the case of applying voltage, higher than the threshold voltage to the pin matrix, gas ionisation will occur near the electrode. These ions are propelled by Coulomb forces

towards the opposite electrode. As they travel, the ions collide with ionised gas molecules and the result of this is a corona wind.

The first two kinds of force are used in electrical grain separators.

The possibility of using electrostrictive forces in the drying process was suggested by Taruškin in 1983. He pointed to the potential of using electrodynamic fields acting on the internal grain structure. He suggested that the mechanical tension generated in a strong electrostatic field cause structural microchanges, which reduce moisture retention and minimise energy consumption in convective drying processes. However, he did not carry out any research to illustrate this.

In 1990, Baran created mathematical formulas describing the influence of electrical properties of grains and their shape on the volume of electrostrictive forces. He calculated that the volume of the electrostrictive forces is a few grades too low to cause macroscopic grain deformation, but he did not exclude the possibility of the influence of these forces on drying processes. Additionally, he carried out tests of grain drying when the grain was exposed to electrostatic field before the beginning of the drying process. As a result he stated that there

---

\*Paper presented at 6 ICA.

This work was supported by the State Committee for Scientific Research under grant No. 5PO6F 001 11.

were no effects on decreasing the drying energy consumption. In the case of Baran's experiments, grains were not exposed to electric field during the drying processes. Nobody knows if there were any stresses in the grain (in the form of remanence) or if they disappeared at the beginning of the drying process. It seems that this is the reason why the experiment did not bear out any changes in the grains moisture retention ability.

The other investigation of using an electrostatic field in the drying process is the paper entitled "Utilization of Strong Electrostatic Field in Drying Process" [1]. The grains were dried in a drum drier. Voltage was applied to the internal and external cylinders of the drier, so they played the role of a cylindrical capacitor. The electric field effect on the drying process was estimated as an energy consuming process reduction index. The results of these experiments demonstrated a decrease of the grain's ability to retain moisture when exposed to an electric field during the whole drying process.

In 1972 Sadek, Fax and Hurwitz published the results of another type of research [4]. They carried out the research on the heat and mass transfer process in convective drying. The medium was sponge with water. It was exposed on

a flat grounded electrode above which a pin matrix was put. Then this was carried out with a flat electrode. As the result it was stated that the factor that increased heat and mass transfer was the corona wind.

In 1995 Wolny published the results of similar research [6]. The convective drying of ceramic substance and water vaporisation from flat and cylindrical surfaces was carried out in an electric field in the presence of a corona wind. The results of the research confirmed the importance of the influence of the corona wind on heat and mass transfer at low air velocity.

### TEST STAND AND PROCEDURE

The main element of the test stand (Fig. 1) is the drying chamber (Fig. 2) with the measurement capacitor inside. The drying samples of wheat grain, placed on the lower electrode, had an initial mass of 100 g. The measurement capacitor was attached to the string of the balance. The electronic balance sends information about the mass of the dried sample to the computer. The supply is DC high voltage. A fan-heater is placed in the inlet of the chamber.

The drying chamber is rectangular. The voltage is applied to the electrodes of the capacitor.

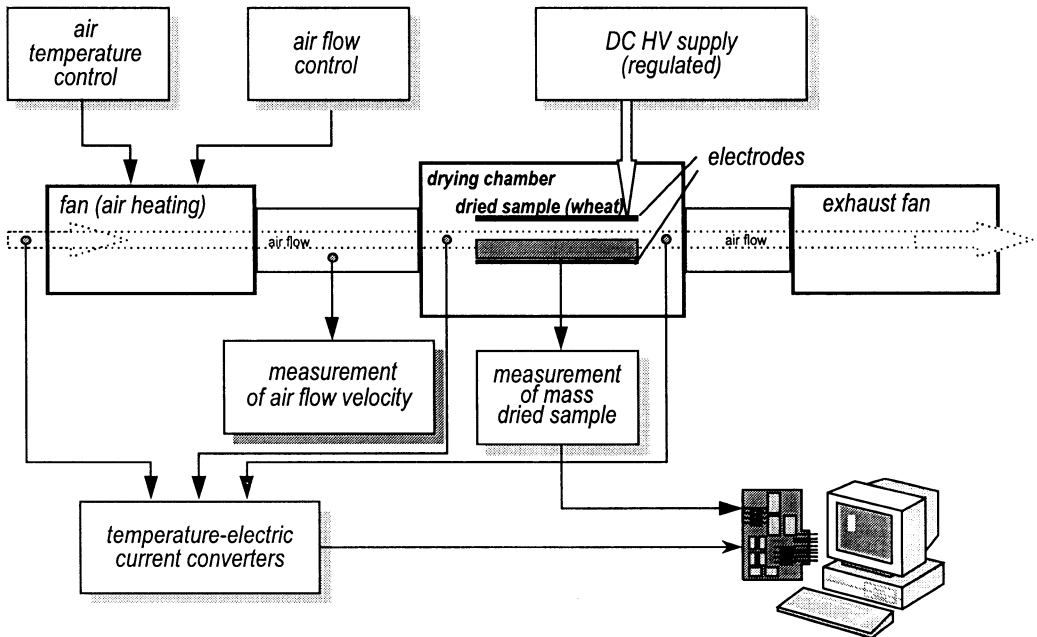

Fig. 1. Block diagram of test stand.

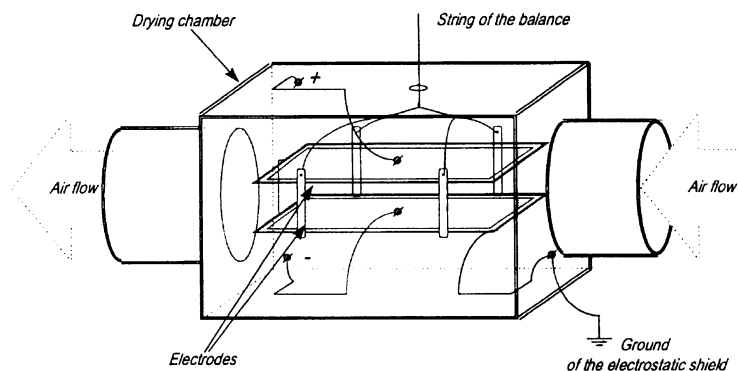

Fig. 2. Drying chamber.

The construction makes it possible to change the bias. During the experiments a few types of capacitors were used. In the case of the pin matrix increased drying was observed. The construction of capacitor allowed the generation of the corona wind.

The drying sample was artificially moistened to a value of 20 %. Every time two series of drying were carried out. In one of them the sample was exposed to the electrostatic field but not in the other. Each drying process lasted 1.5 h. The computer registered the weight loss of vapourised water every 2 min.

The following series of the measurements were carried out:

- in configuration of flat electrodes and in configuration with upper electrode equipped with pin matrix;
- the range of drying air velocity was from 0.3 to 1.4  $\text{m s}^{-1}$ ;
- the range of field intensity was: 0, 200, 300 and 400  $\text{kV m}^{-1}$ ;
- the range of air temperature was: 303, 313 and 323 K.

## RESULTS

The following results were found:

- In the flat capacitor - in which the corona wind was not generated, there was no measurable influence of the field on the drying process. This means that in the given configuration, there is no mass transfer augmentation caused by electrostrictive forces.
- In both types of capacitors, at high air velocity, the mass transfer augmentation does

not exist. With the air velocity higher than 0.3  $\text{ms}^{-1}$  it was impossible to register measurable changes in either type of drying process.

The illustration of the dynamic of the drying process could be these three groups of curves. The most exact results were obtained by analysing the curves gained on the basis of the real temperature and real electric field intensity, not the mean. The advantage of this type of analysis is the possibility of obtaining the same initial moisture of the wheat. Curves were plotted for all combination parameters of drying. On their basis the energy reduction index and corona current density were calculated. The most visible effects of the field on the wheat were observed at the maximal electric field intensity and the maximal temperature (323 K, 400  $\text{kV m}^{-1}$ ) (Figs 3-5). The field caused, after 1.5 h of the drying, a difference in the sample mass of 1.5 g (Fig. 3). From the slope of the curve we can conclude that the most intensive increase of water vaporisation was in the first period of drying.

The drying curves illustrate the same. Their ending slope shows that the drying could last a little longer to gain the lowest possible moisture at this temperature. Apart from that the sample exposed to the field reached the moisture level of the sample that was not exposed 34 min earlier (Fig. 4).

The third curves show the rate of drying (Fig. 5). The following curves are the approximation of the results of the measurements with the help of the polynomial of the second order. They show that in the first moment the rate of vaporisation is twice higher.

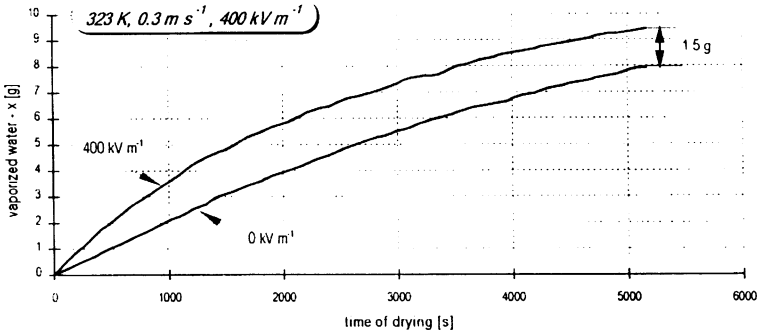

Fig. 3. Water removed from the sample of the wheat versus time of drying.

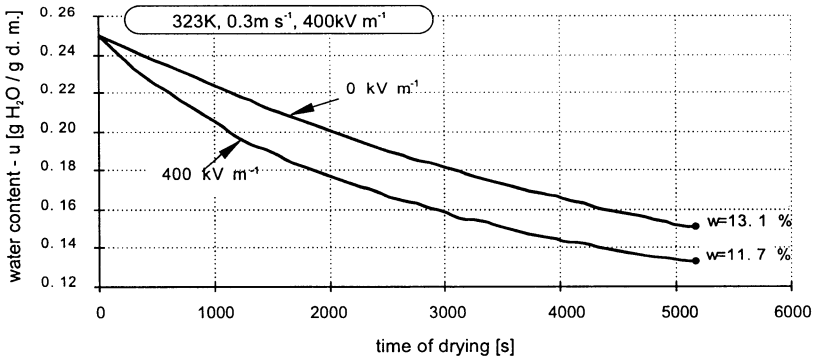

Fig. 4. Drying curves of Roma wheat.

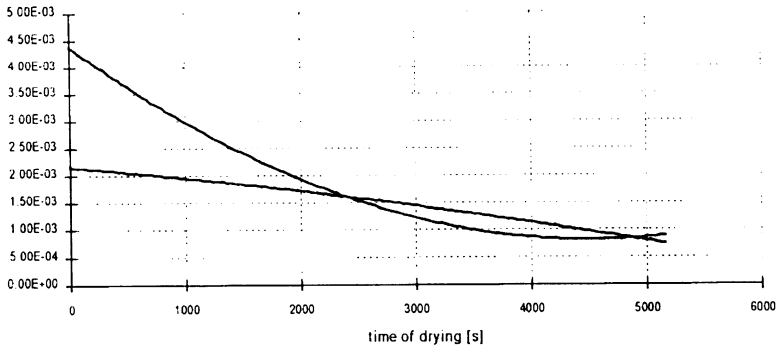

Fig. 5. Rate of drying of Roma wheat.

The other curves show the drying process at different temperatures used at all electric field intensities (Fig. 6). The first visible effect of using this field is the acceleration of drying with increasing field intensity. At any temperature, the more the electric field intensity, the more the augmentation of water vaporisation is. This influence grows with temperature. It is not important that on the 200kV m<sup>-1</sup> curves augmentation is not

visible. The effect of using the lowest intensity is visible on the detailed curves plotted specially for this group of measurements. The maximal evaporation was gained at a temperature of 323 K and an electric field intensity of 400 kV m<sup>-1</sup>.

To illustrate the drying acceleration visible on the curves, a special convective energy reduction index  $q\%$  was introduced to compare the two processes [1]. In this index, it is a assumed

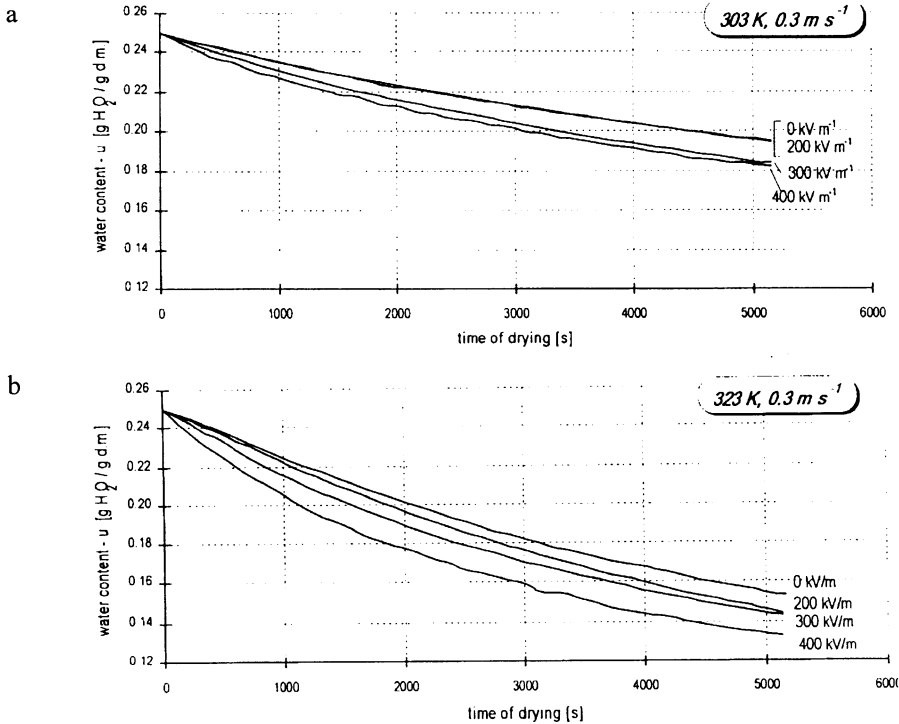

Fig. 6. Drying curves of Roma wheat at 323 K (a) and 323 K (b) temperatures.

that the compared samples have the same initial mass and that the quantity of energy given by the fun heater is the same in each process. Having information about the starting mass  $M$ , moisture content  $u$  or humidity  $w$ , it is possible to compare convective energy consumed in both cases:

$$q\% = \left( \frac{u - u_2}{u - u_1} - 1 \right) 100\%$$

where  $u$  is moisture content in a grain before drying, %,  $u_1$  - moisture content of a grain not exposed to an electric field during drying process, %,  $u_2$  - moisture content of a grain exposed to an electric field during drying process, %.

The convective energy consumption coefficient  $q$  describes only the changes of energy that is supplied to wheat grain by means of a drying medium (air) but it does not refer to the electric energy introduced to the system.

The computations of  $q$  do not include electric energy because the mechanism of the influence of an electric field on the drying processes

has not been definitely determined yet. This problem is to be investigated in further research.

The maximal convective energy reduction index calculated on the basis of moisture content after 90 min of drying was gained in the case of the maximal electric field intensity (Fig. 7). The index changed its value from 3.6% at 200  $\text{kV m}^{-1}$  and a temperature of 303 K to 37.4% with 400  $\text{kV m}^{-1}$  and a temperature of 323 K. It must be remembered that the acceleration of water vaporisation was gained with the help of the corona wind.

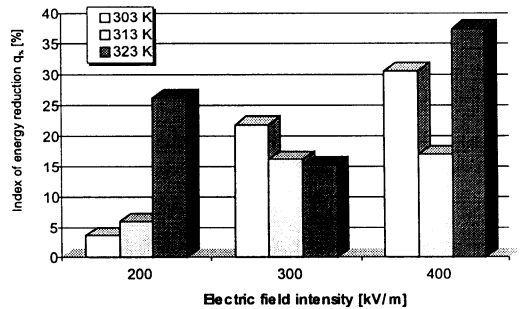

Fig. 7. Index of reduction convective energy consuming.

The corona current density was calculated on the basis of the area of the lower electrode. The value of the corona current was gained from the registered high voltage current. The value of the current density changed from  $850 \mu\text{A m}^{-2}$  at  $200 \text{ kV m}^{-1}$  to  $14700 \mu\text{A m}^{-2}$  at  $400 \text{ kV m}^{-1}$  (Fig. 8). It must be stressed that the values are connected only with the initial part of the drying process. After some time these values decreased. This means that the acceleration of water vaporation is caused by the corona wind.

- The energy consumption did not change under the influence of electrostrictive effects. This may be caused by the fact that the samples were artificially moistened, which may have caused the grains loses its flexible properties.
- The increase of electric field intensity, and the increase of the corona wind, caused an increase in the rate of vaporisation.
- The acceleration of water vaporisation occurs at low air velocity, which is  $0.3 \text{ m s}^{-1}$ .

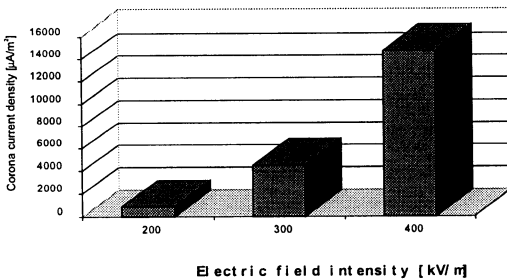

Fig. 8. Corona current density.

#### CONCLUSIONS

On the basis of the measurements, the following can be concluded:

- In each group of measurements in which the corona wind occurs the drying process was accelerated. The maximal convective energy reduction index was 37 %.

#### REFERENCES

1. **Kraskowiak J., Pietrzyk W.:** Utilization of strong electrostatic field in drying process. 7<sup>th</sup> International Symposium on High Voltage Engineering, Dresden, 37-38, 1991.
2. **Lykoudis P.S., Yu C.P.:** The Influence of electric forces on natural thermal convection. *J. Heat Mass Transfer*, 6, 853-862, 1963.
3. **Pietrzyk W., Sumorek A.:** Tests to determine the character of striction forces (in Polish). 20<sup>th</sup> Seminar on Fundamentals of Electrotechnics and Circuit Theory, 133-136, 1997.
4. **Sadek S.E., Fax R.G., Hurwitz M.:** The influence of electric fields on convective heat and mass transfer from a horizontal surface under forced convection. *J. Heat Transfer, Trans. ASME*, 94, C, 2, 144-148, 1972.
5. **Senftleben H.:** Die Einwirkung elektrischer und magnetischer Felder auf Wärmeleitvermögen von Gasen. *Phys. Zeitschr.*, 32, 550, 1931.
6. **Wolny A.:** The influence of electric field on cylindrical surface drying. VII Symposium of Drying, II, 241-245, 1991.